

BIO BS4

Digital Endoscope

User's Manual









TABLE OF CONTENTS

- 1. Category**
- 2. Symbols**
- 3. Warnings and Cautions**
- 4. Intended for use**
- 5. User interface**
- 6. Operating instructions**
- 7. Recharging and Data Transferring**
- 8. Instruction of Power Indicator**
- 9. Battery Replacement**
- 10. Cleaning and Disinfection**
- 11. Operation Environment**
- 12. Storage Environment**
- 13. Technical Description**
- 14. Liability**
- 15. Warranty**
- 16. Accessory kit**

Category

Model Name	Product Name	Accessory
BIO Scope DOC-100	Digital Otoscope	Specula
BIO Scope DDC-100	Digital Dermatoscope	Contact plate
BIO Scope DGC-100	General Imaging	

1. Symbols

	Attention. Read user's manual for cautions and instructions for use.
	Type BF – Indicates this is a product with Type BF applied parts.
	Operating instructions for use.
	Manufacturer
	Date of manufacturer
	Authorized representative

2. Warnings and Cautions

PLEASE NOTE:

Prior to installation and start-up of the unit, carefully read the instructions provided here in! As with all technical devices, the proper function and safe operation of this unit depend on the user's compliance with the safety recommendations which are presented in these operating instructions.

CAUTION:



Always use the Scope in accordance with the directions and recommendations contained in this User Manual.



CAUTION:

To prevent fire or electrical shock, do not expose these appliances to rain or moisture.



CAUTION:

This unit is not waterproof .If the optical lens and the control unit get wet; do not attempt to dry with a heater, microwave, autoclave or UV light.



CAUTION:

Avoid subjecting the Scope to vibration or shock. When the product is not in use, please disconnect the power plug and keep it in a safe place.



CAUTION:

Avoid using the Scope in a dusty environment, and keep the power cord away from any heat source.



CAUTION:

The eye can't be exposed to the illumination light of system at operation.



CAUTION:

Before operation, please make sure the appearance is not damaged or broken. If there are breaks in the device cover or other visual defects, please contact BIO or BIO certified service facility.



CAUTION:

Only use Li-ion Battery 3.7V / 2600mAh which shall be provided by the manufacturer and distributors.



CAUTION:

If you purchase different memory capacity of Micro SD Card, must be preceded format to FAT32.



CAUTION:

Replace the disposable specula of BIO Scope DOC-100, Digital Otoscope, before each use for a new patient.

CAUTION:



Let the specula BIO Scope DOC-100, Digital Otoscope, to gently insert into the ear canal and have to keep a safety distance between the specula and tympanic membrane. Do not make the specula contact with ear's tympanic membrane.

CAUTION:



Clean the contact plate of BIO Scope DDC-100, Digital Dermatoscope, before each use for a new patient. Disinfect the contact plate with soft cloth moistened with alcohol (70% ethyl alcohol). Replace the disposable contact plate if necessary.

3. Intended for use

BIO scope DOC-100 is a digital hand-held otoscope used to record digital photographs and video of the human ear's canal and tympanic membrane.

BIO scope DDC-100 is a digital hand-held dermatoscope used to record digital photographs and video of the human skin.

BIO scope DGC-100 is a digital hand-held camera used to record digital photographs and video of the human body.

4. User interface

Front View

LCD Monitor

Picture/Video
Mode Switcher
(Switching time is
about 5 seconds)

Brightness
Decreasing/
Back to Normal
Picture Size.

Power Indicator

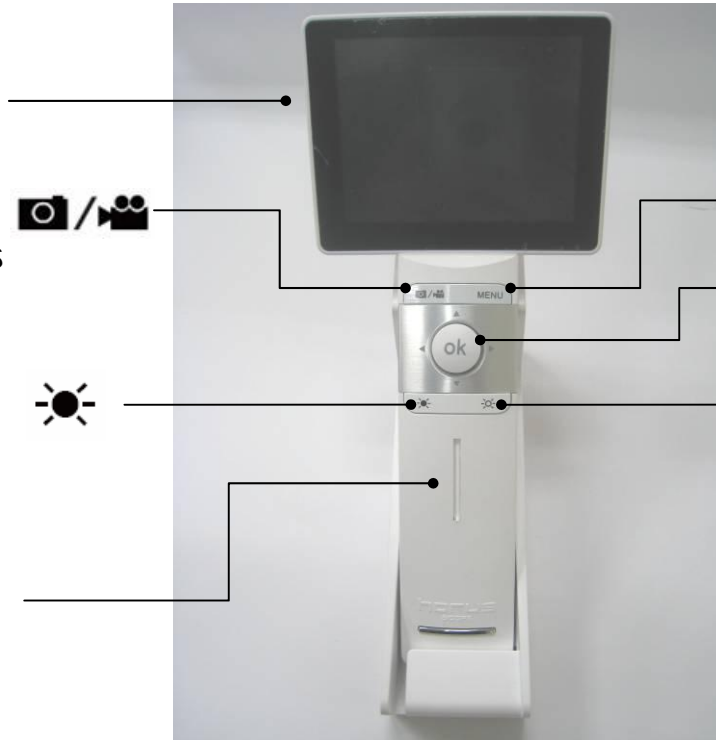

MENU

OK: Capture/Enter

Brightness
Increasing/
Zoom In Picture:
Move the picture
by pressing the
arrow button.

Top View



Power Button

Rear View



Bottom and Right Views

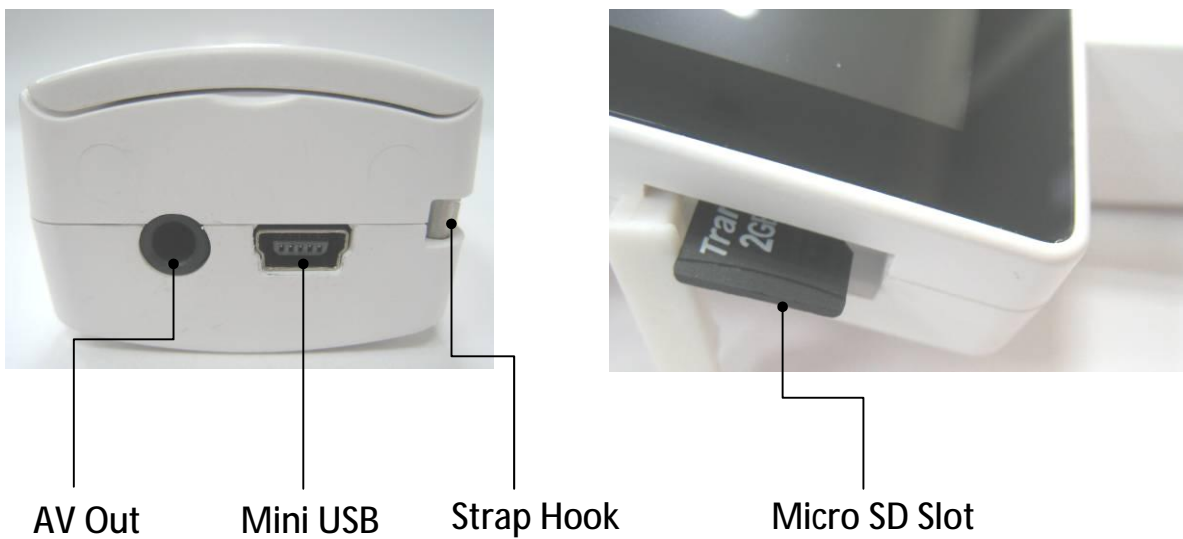

Charger Station



Mini USB

Optical Lens of BIO Scope DOC-100

Digital Otoscope

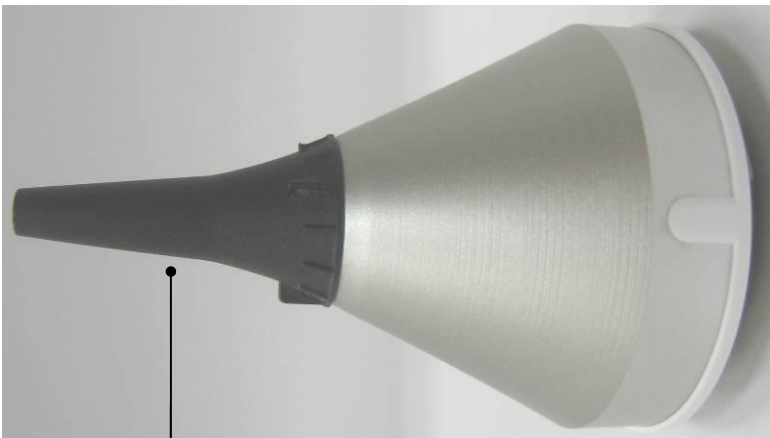

Specula

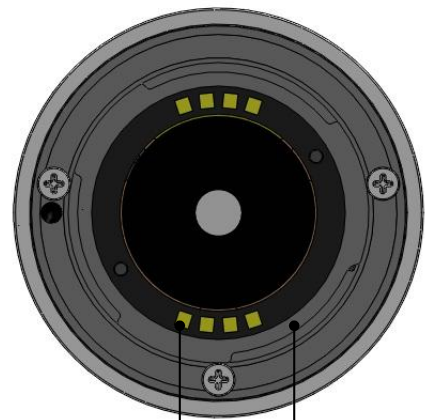

Signal Pad

Contact Ring

Optical Lens of BIO Scope DDC-100

Digital Dermatoscope

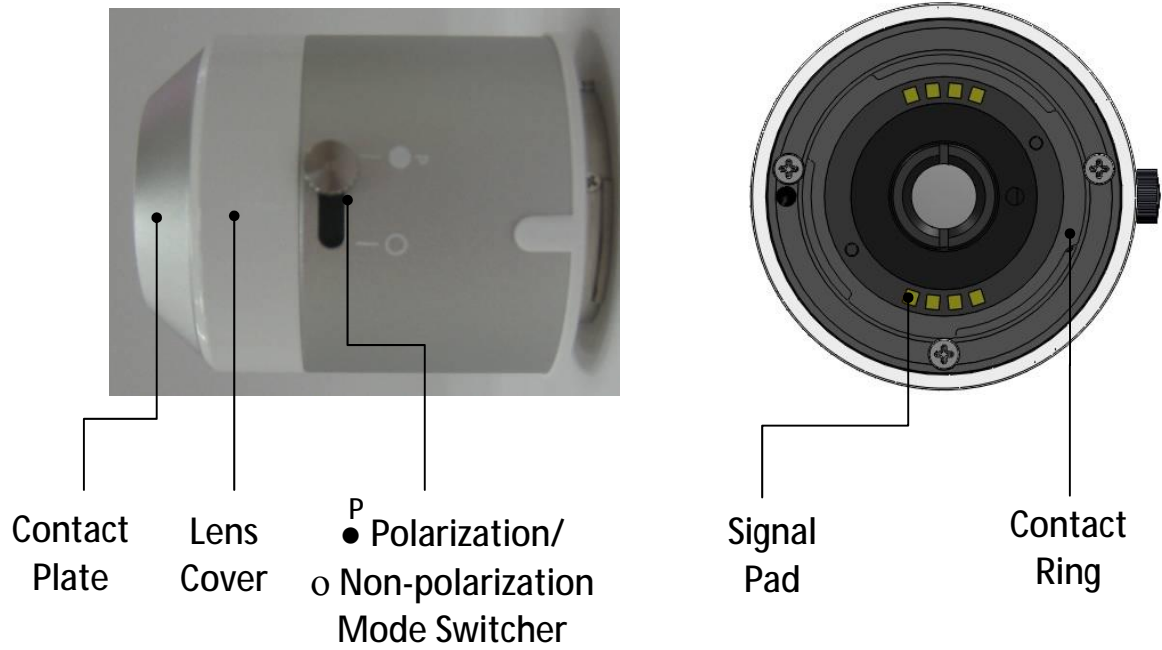

Optical Lens of BIO Scope DGC-100

Digital General Imaging

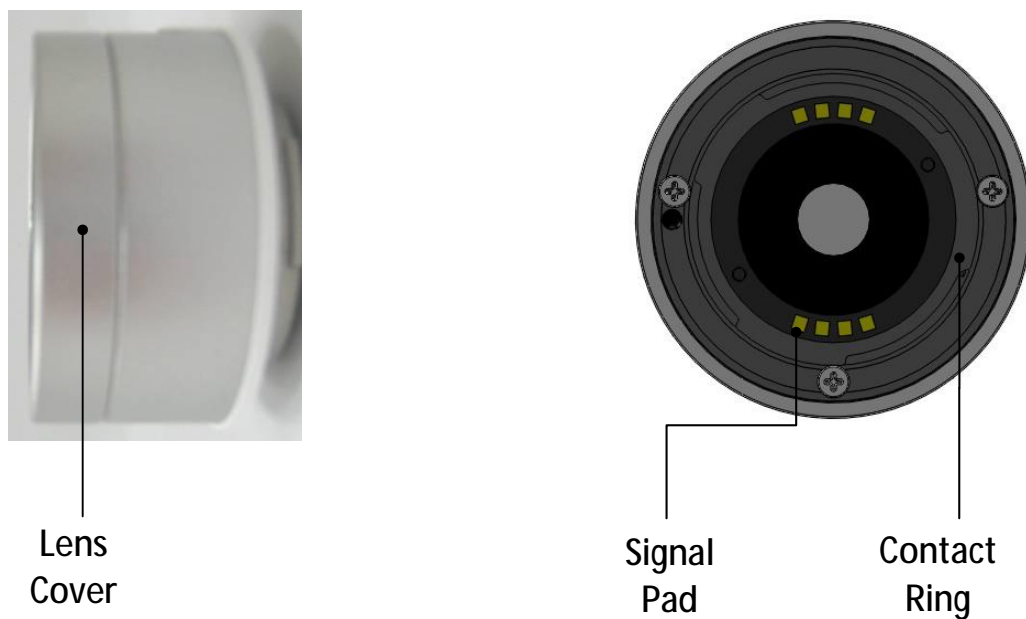

5. Operating instructions

Step 1: Align the Marks of Optical Lens and Control Unit.

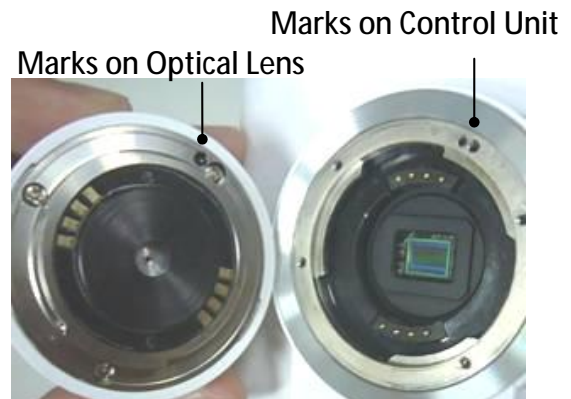

Step 2: Hold Optical Lens and attach it on Control Unit.



Step 3: Rotate and fasten Optical Lens in a counter-clockwise direction, where as the “Deco Ring” is at the “Horizontal” direction.

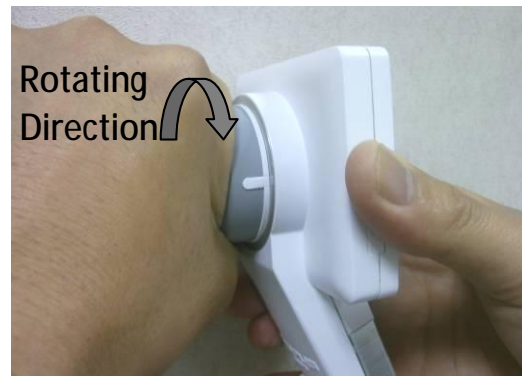

Step 4: Before the first use, insert the battery to the scope and close the battery cover referring to Section 6. Place the scope on Charger Station or connect to adapter via USB cable. Connect USB connector to the power plug. Let the battery charged for five hours.



Step 5: The scope is powered on by pressing the power button. Approximately 1~2 seconds later, the starting picture indicates on the LCD display.



Power Button

Step 6: Approximately for 20 seconds, the graphical indicators display on the top row of the LCD display. The user can start to capture the photograph in the picture mode.



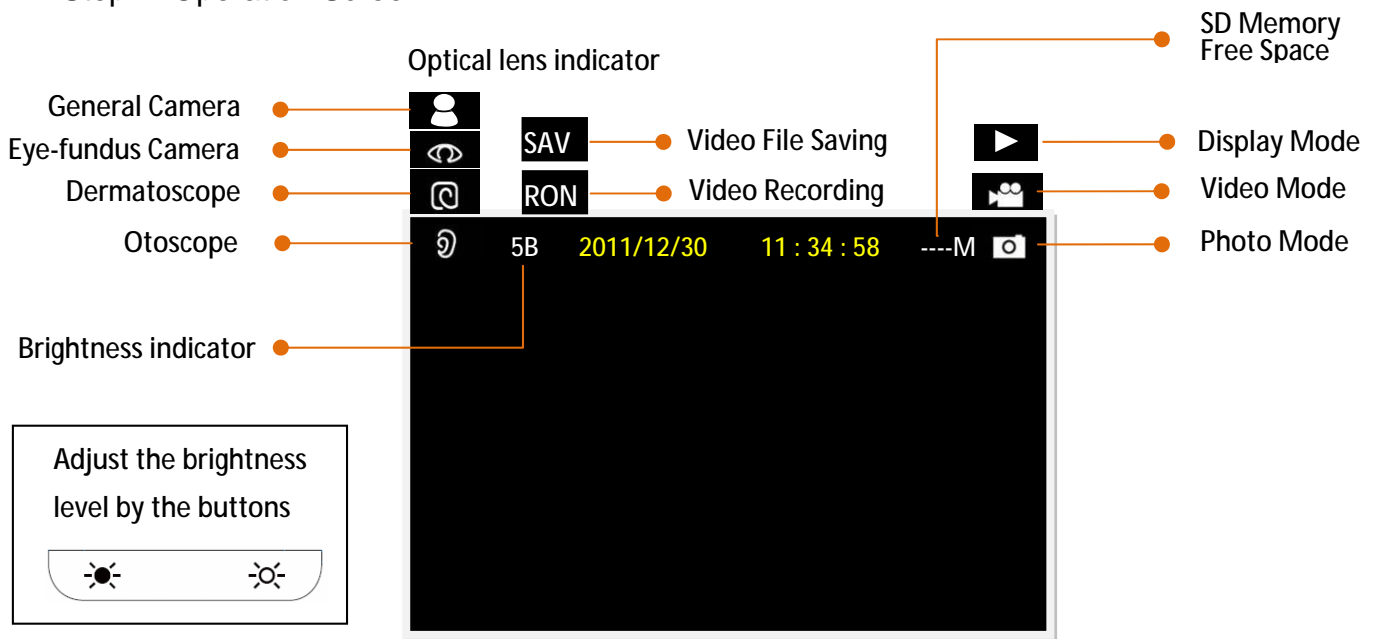

Step 7: Operation Screen

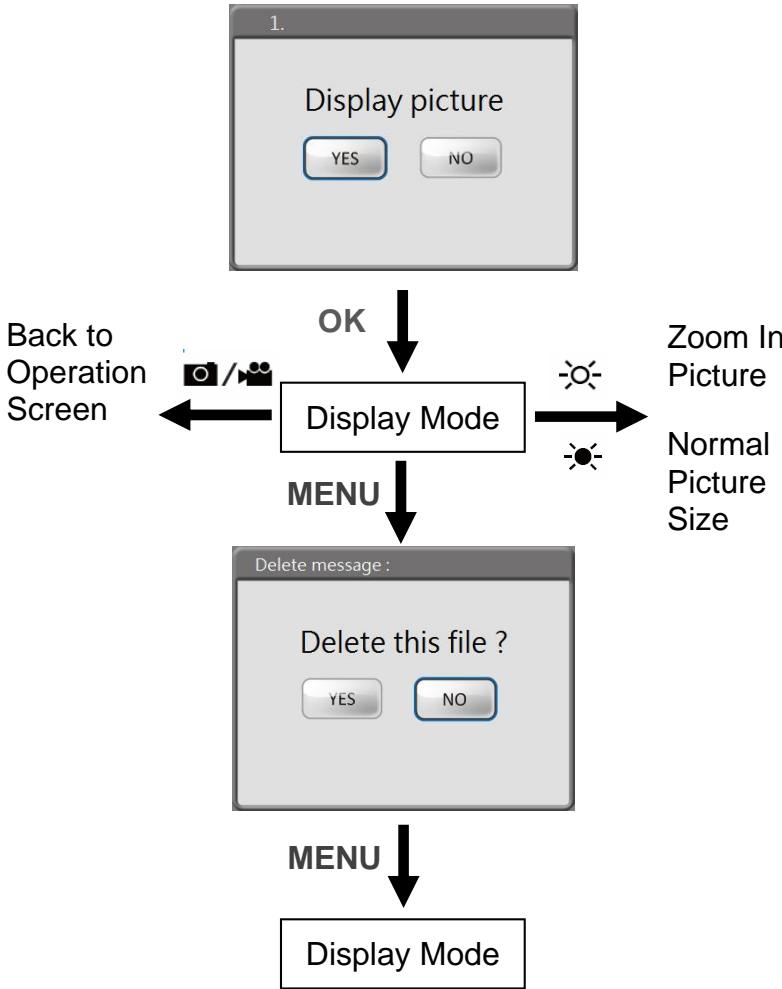

Step 8: Menu Screen

- Press “Menu” button and enter to “Menu” mode. It is recommended to set the operation condition according to the user’s requirement for the first time use.
- The user can press r / s to switch the pages as shown the table below.
- The user can press v / w to select “YES” or “NO”. And press “OK” button to confirm your choice.
- Press “Menu” button again. The user can return to the Operation Screen, and then start to capture the photograph or record the video in the selected mode.
- The functional setting is described and shown in the table below.
- The “Menu” screen will return to Operation Screen in 15 sec without pressing any button or the user can press “Menu” button and return to Operation Screen.

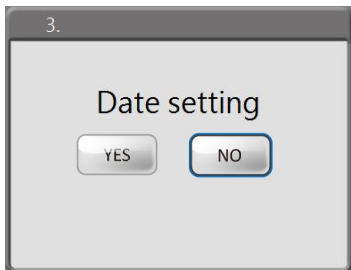
Page	Legend	Description	Setting
1			<p>1. Product doesn't support the video file display. Please download the video file (.avi) to computer to display.</p> <p>2. At "Display Mode", the file name is displayed at the upside of the viewing picture.</p> <p>3. At "Zoom In" mode, press r s v w to see the different area of the picture.</p>
2		<p>Icon display or not</p> <p>YES: Show icon, date, time.</p> <p>NO: Hide icon, date, time.</p>	<p>Default Value : YES</p>
3		<p>Date Setting</p> <p>YES: Date setting</p> <p>NO: Skip</p>	<p>Default value: (year-month-day)</p> <p>r s : Adjust the value</p> <p>v w: Select year/month/day</p> <p>Press "OK" button once the user confirms the setting.</p>

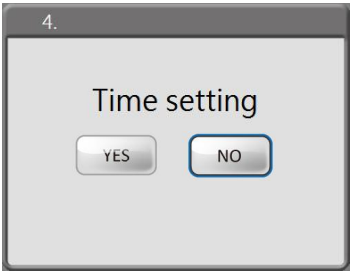
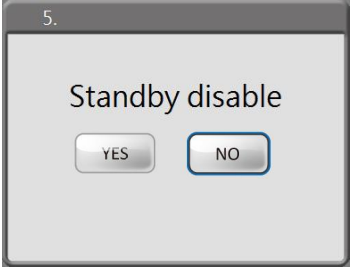
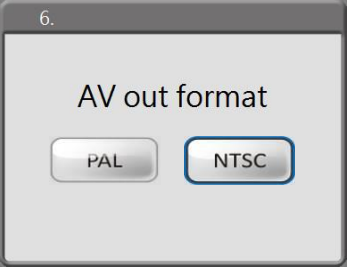
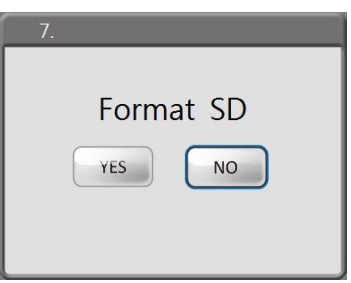
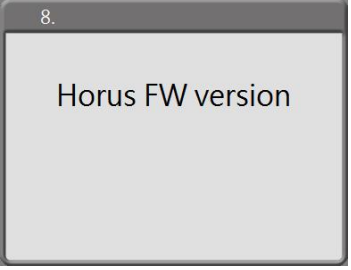
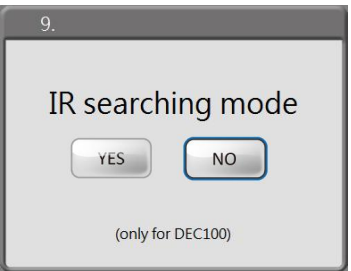
4		<p>Time Setting</p> <p>YES: Time setting NO: Skip</p>	<p>Default value : (hour : minute)</p> <p>r s : Adjust the value v w:Select hour /minute Press "OK" button once the user confirms the setting.</p>
5		<p>Standby Function Disable</p> <p>YES: Disable NO: Enable</p>	<p>Default value: Enable</p> <p>Press "OK" button once the user confirms the setting.</p>
6		<p>Video output type</p> <p>NTSC PAL</p>	<p>Default value : NTSC</p> <p>Press "OK" button once the user confirms the setting.</p>
7		<p>SD card format</p> <p>YES: Mark SD card format NO: Skip</p> <p>Note: All information will be deleted after SD card is formatted.</p>	<p>Default value : NO</p> <p>Select "YES" and press "OK" button if the user wants to format SD card. LCD monitor turns off while the file is formatting.</p>
8		<p>Version of software</p> <p>Press "OK" to check the version of software.</p>	<p>Default value :</p>
9		<p>Searching mode selection</p> <p>YES: IR Search / VR Photo NO: VR Search / VR Photo</p>	<p>Default value : IR Search/VR Photo</p>

Step 9: Image-capturing by the BIO Scope

After Optical Lens is attached on the Control Unit and “Menu” setting is completed. The user can start to capture the images. Approaches for capturing the images as follows:

1. For BIO Scope DOC-100, Digital Otoscope, let the Specula to gently insert into the ear canal and have to keep a safety distance between the specula and tympanic membrane. Do not make the specula contact with ear's tympanic membrane.
2. For BIO Scope DDC-100, Digital Dermatoscope, let the Contact Plate to gently contact with the skin.
3. For BIO Scope DGC-100, Digital General Imaging, move Optical Lens to the object at the distance as the image shown on LCD display is that the user wants to capture and record.
4. Adjust the brightness of the illumination by pressing buttons.  buttons.
5. Adjust and optimize the image in focus by rotating the Focus Wheel.
6. Press “OK” button to capture the photograph or record the video.
7. The display will be frozen without any action. The image file is saved in the SD card. Press “OK” button if the user wants to return to operation screen and take the other images.
8. Replace the disposable specula before each use for a new patient.

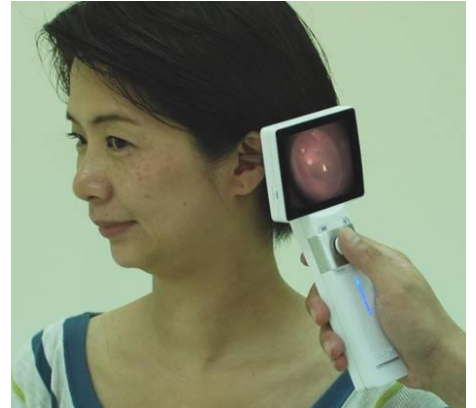

Step10: Transfer images to the electronic device, for example, personal computer, laptop or mobile phone, via the USB cable connecting to Control Unit and Charger Station, or Micro SD card.





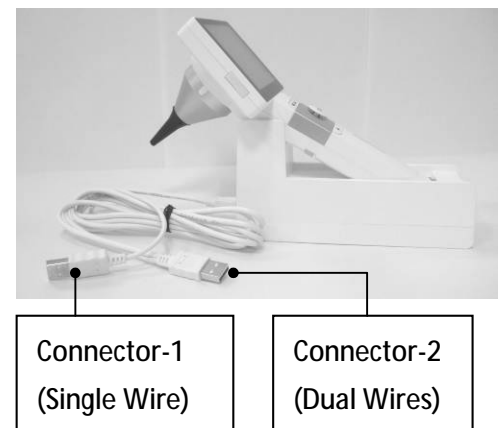

6. Recharging and Data Transferring :

Place the BIO Scope and USB cable to the Charger Station, as right picture showed.

- Connector-2 to computer for recharging and data transferring.
- Connector-1 to computer for recharging only.
- Connector-1 or Connector-2 to Power Adapter for recharging only.



7. Instruction of Power Indicator :

State of Power Indicator			Power Mode	Power Capacity	Recharging Mode
1	Blue-colored Light		ON	Full 100%	YES
			ON	Higher than 25%	NO
			Stand-By	Higher than 25%	NO
2	Blue-colored Light on the top and orange-colored light on the bottom		Stand-By	Less than 100%	YES
3	Orange-colored Light		OFF	Less than 100%	YES
4	Sparkling blue-colored light		ON	Less than 25%	NO
			OFF	Less than 25%	NO
5	No light		OFF	Higher than 25%	NO

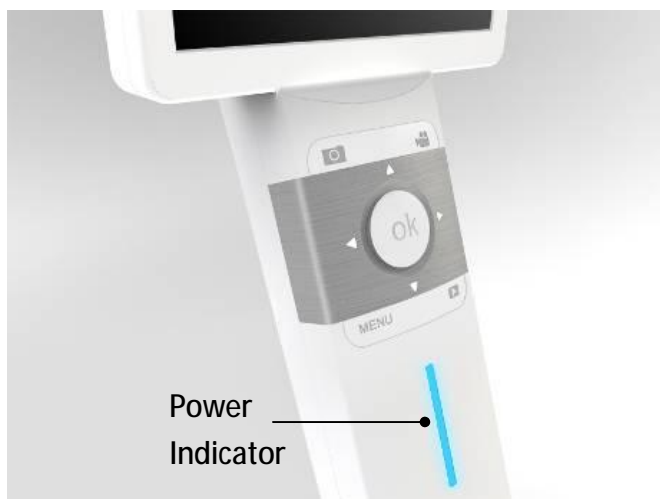

8. Battery Replacement

Battery Replacement



- Open the battery cover by digging out the gap in the bottom of battery cover with a finger or something pointed.
- Tilt the battery cover and remove the battery cover by lifting it up.
- Remove the original battery and replace a new battery along the correct direction.
- Place the battery cover and secure it in place.

9. Cleaning and Disinfection

The BIO Scope is a precision photoelectronic instrument that shall be handled with specific care. Please note following cleaning instructions:

- Power off the BIO Scope before cleaning it.
- Disinfect the control unit and charger station with the soft cloth with alcohol. Wait for cleaning liquid to dissolve before power on and connecting the charger station and USB cable to the control unit.
- It is recommended to clean the optical lens with cleaning cloth or lens cleaning tissue such as THORLAB Inc., (www.thorlabs.com) Lens Cleaning Tissue.

If the replacement for new disposable specula or new contact plate is needed, please contact with manufacturer or your own retailer.

Clean the contact plate before each use for a new patient:

- Disinfect the contact plate with soft cloth moistened with alcohol (70% ethyl alcohol).

Note: The BIO Scope is not intended to be sterilized.

10. Operation Environment

- Ambient temperature 0°C to +35°C
- Relative humidity 10% to 80%
- Atmospheric pressure 700hPa ~ 1060hPa

11. Storage Environment

- Ambient temperature -10°C to +40°C
- Relative humidity range 10% to 95%
- Note: It is recommended to remove the battery if the BIO Scope is stored over 2 weeks.

12. Technical Description

BIO Scope DOC-100, Digital Ootoscope:

- Focusing range 5~30 mm
- Dimension 8.5 × 9 × 20 cm³
- Weight 330 Grams

BIO Scope DDC-100, Digital Dermatoscope:

- Focusing range 10 mm diameters
- Dimension 8.5 × 8 × 20 cm³
- Weight 370 Grams

BIO Scope DGC-100, Digital General imaging:

- Focusing range 80 degrees (Diagonal)
- Dimension 8.5 × 5 × 20 cm³
- Weight 310 Grams

General Specification:

- Resolution 1920 x 1080 pixels
- Light Source Neutral White Light Emitting Diode (LED)
- LCD Monitor 3.5" Full Color TFT-LCD
- Image Format JPEG (Photograph) and H.264 (Video)
- Interaction Port Mini USB, Phone Jack Port
- Media Type Micro SD Memory Card, 2GB.
- Power Source Rechargeable Lithium Battery 3.7V / 2600mAh
- External Power Source: 100~240 VAC, 50/60 Hz
- Operating time 3 hours at 2.5 Watt condition
- Charging time 5 hours

13. Liability

Consider itself responsible for the effects on safety, reliability and performance of this product only if:

- Assembly operations, extensions, re-adjustments, modifications or repairs are carried out by persons authorized.
- The electrical installation of the relevant room complies with the requirements.
- The equipment is used in accordance with these instructions for use.

14. Warranty

- Wuxi Biomedical Technology Co.,Ltd provides the BIO Scope one year warranty for the parts. Warranty for battery is six months.
- The warranty starts at the delivery date.
- Natural disasters, man-made damage, lack of reasonable care, disassembly, upgrade, and warranty sticker had been torn up or phase-out parts are not included in the warranty.

15. Accessory kit

The Li-ion Battery capacity is 3.7V / 2600mAh. The battery has designed the protection circuit. To ensure the safety of the product operation. If the battery reaches lifetime or failure, please contact the manufacturer or distributor to buy the spare battery.